

# User's Manual



## **Elite Silent Series** **INVERTER POOL HEAT PUMP**



## Table of contents

<b>A. Foreword</b>	<b>1</b>
<b>A. Safety Precautions</b>	<b>2</b>
1. Warning	2
2. Attention	3
3. Safety	3
<b>B. About your heat pump</b>	<b>4</b>
1. Transportation	4
2. Accessories	4
3. Features	5
4. Operating condition and range	5
5. Introduction of different modes	5
6. Technical parameters	6
7. Dimensions	7
<b>C. Installation</b>	<b>8</b>
1. Installation requirements	8
3. Wiring requirements	9
4. Electric wiring Diagram	10
5. References for protection devices and cable specification	10
6. Installation options	11
<b>D. Operation guidance</b>	<b>15</b>
1. Display Functions	15
2. Operation Instruction	16
<b>E. Testing</b>	<b>18</b>
<b>F. Commissioning</b>	<b>19</b>
<b>G. Maintenance</b>	<b>20</b>
<b>H. Trouble shooting for common faults</b>	<b>21</b>
<b>I. Appendix</b>	<b>24</b>
<b>Water Testing Pump Output</b>	<b>27</b>
<b>External input</b>	<b>27</b>
<b>J. Wi-Fi operation</b>	<b>28</b>
<b>K. Ventilation</b>	<b>6</b>
<b>L. Product Purchase Warranty Registration</b>	<b>10</b>

## A. Foreword

Thank you for choosing the Madimack high efficiency inverter pool heat pump.

All our heat pumps are built and designed to the highest standard and are protected by our extended warranty service for peace of mind.

Warranty registration is required to be submitted online in conjunction with the commissioning page and warranty registration page in the Appendix section at the back of the booklet

[www.madimack.com.au/warranty-registration](http://www.madimack.com.au/warranty-registration)

Please read and fully understand all information provided before attempting to install the pool heat pump.

For technical questions and further information please contact  
[sales@madimack.com.au](mailto:sales@madimack.com.au)

We hope you enjoy using our heat pumps.

Thank you!



# A. Safety Precautions

---

We have provided important safety messages in this manual for the installation, maintenance and repair of your heater.

Please read thoroughly and obey all safety messages.

**Environmentally friendly R32 Refrigerant is used in this heat pump**

## 1. Warning

---



This WARNING sign denotes a hazard. It calls attention to a procedure, practice, or the like, which, if not correctly performed or adhered to, could result in personal injury or injury to a third party. These signs are rare, but are extremely important.

	a. Keep the heat pump away from fire source.
	b. Unit must be placed in a well-ventilated area; indoor or enclosed areas are not allowed.
	c. Repair and disposal must be carried out by trained service personnel
	d. Vacuum the system completely before welding. Welding should only be carried out by professional trained personnel.

## 2. Attention

---

- a. Please read the following instructions before installation, use and maintenance.
- b. Installation, must be completed only by competent persons only, and in accordance with this manual.
- c. Check all water connections are sealed and tested before operating the heat pump
- d. Except for the methods recommended by the manufacturer, do not use any methods to accelerate the defrosting process or clean the frosted parts.
- e. If a repair is required, please contact the nearest after-sales service center. The repair process must be strictly in accordance with this manual. Repairs made by unauthorized persons may void the warranty.
- f. Correctly set temperature required for personal preference making sure to avoid overheating or overcooling.
- g. Please do not stack substances or other materials which may block the air flows to the inlet or outlet areas. This causes the efficiency of the heater to be reduced, and may damage the machine.
- h. Do not use or stock combustible gas or liquids such as thinners, paint and fuel, to avoid fire!
- i. In order to optimize the heating effect, please install heat preservation insulation on pipes between swimming pool and the heater, and please use a recommended cover on the swimming pool.
- j. Connecting pipes of the swimming pool and the heater should be less than 10m.

## 3. Safety

---

- a. Please keep the main power supply out of reach from the children.
- b. If power is suddenly disconnected during operation, and later the power is restored, the heater will start up automatically.
- c. Please switch off the main power supply in high storm weather to prevent the machine from damage that could be caused by lightning strikes.
- d. Any repairs should be carried out in a well-ventilated area. Any source of ignition is prohibited during the inspection.
- e. Safety inspections must be carried before the maintenance or repair for heat pumps with R32 gas in order to minimize the risk.
- f. If R32 gas leaks during the installation process, all operations must be stopped immediately and call your local service center.

## B. About your heat pump

---

### 1. Transportation

---

a. Always keep upright

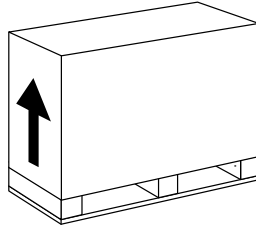

b. Do not lift with the water unions  
(The titanium heat exchanger inside the heat pump may be damaged)

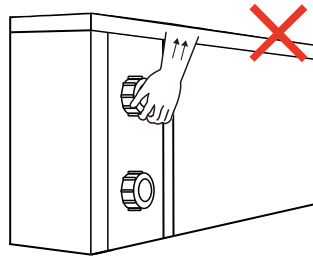

### 2. Accessories

---

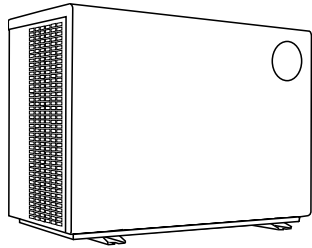

**Water Union**

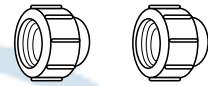

**Drainage kit**

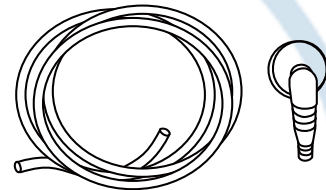

**Connection of the condensate drainage kit:**

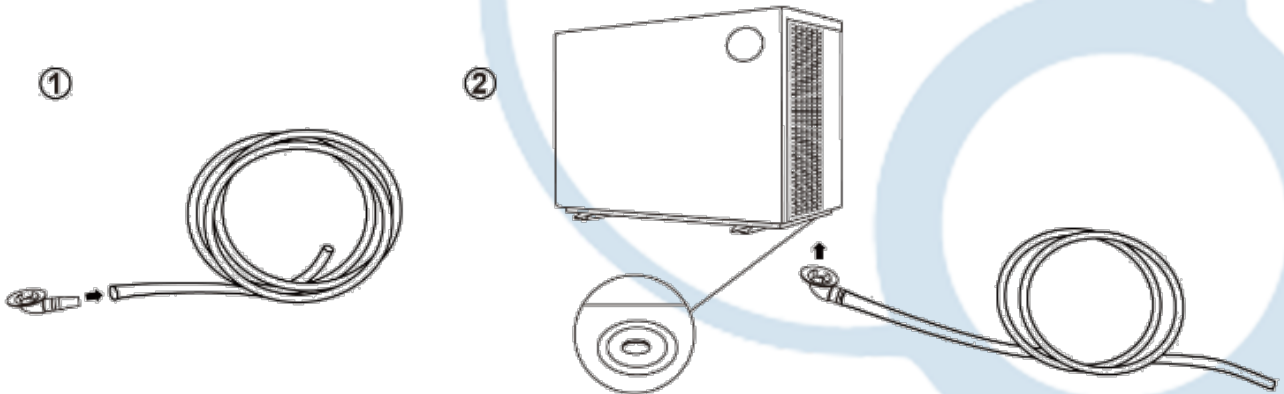

### 3. Features

---

- a. DC Twin-rotary inverter compressor of Mitsubishi
- b. DC Brushless fan motor
- c. EEV Technology
- d. High-efficiency twisted titanium heat exchanger
- e. Sensitive and accurate temp control and water temp display
- f. High pressure and low pressure protection
- g. Full protection on electrical system

### 4. Operating condition and range

---



To provide you comfort and pleasure, please set swimming pool water temperature efficiently and economically.

- a. Air temperature operating range:  $-10^{\circ}\text{C} \sim 43^{\circ}\text{C}$
- b. Heating temperature setting range:  $18^{\circ}\text{C} \sim 40^{\circ}\text{C}$
- c. The heat pump will have best performance in operating temperature range of ambient Air  $15^{\circ}\text{C} \sim 25^{\circ}\text{C}$

### 5. Introduction of different modes

---

- a. The heat pump has two modes: Boost and Silent
- b. They have different strengths under different conditions.

Mode	Modes	Strength
	Boost mode	Heating capacity: 20% to 100% capacity Intelligent optimization Fast heating
	Silence mode	Heating capacity: 20% to 80% capacity Sound level: 3dB (A) lower than Boost mode

## 6. Technical parameters

Model	ES70/ 240MM	ES90/ 240MM	ES110/ 240MM	ES130/ 240MM	ES150 /240MM	ES170/ 240MM	ES210/ 240MM	ES280/ 240MM	ES280S/ 400MM	ES350S/ 400MM
<b>PERFORMANCE CONDITION: Air 27°C/ Water 27°C/ Humid. 80%</b>										
Heating capacity (kW)	7.0	9.0	11.0	13.0	15.0	17.5	21.0	26.0	28.0	35.2
COP Range	14.0~7.2	14.0~7.2	14.0~7.0	14.5~7.0	15.0~7.0	15.6~7.0	14.8~7.1	16.0~7.2	15.8~7.1	15.5~7.0
<b>PERFORMANCE CONDITION: Air 15°C/ Water 26°C/ Humid. 70%</b>										
Heating capacity (kW)	5.0	6.6	7.7	9.0	10.5	12.5	14.5	19.0	19.0	24.2
COP Range	7.3~4.5	7.5~4.8	7.3~4.7	7.5~5.0	7.7~4.9	7.7~5.0	7.1~5.0	8.0~5.0	8.0~5.0	7.5~5.0
<b>TECHNICAL SPECIFICATIONS</b>										
Operating air temperature (°C)	-10°C~43°C									
Power supply	230V 1PH								400V 3ph	
Rated input power (kW)	0.14~1.12	0.19~1.38	0.22~1.64	0.26~1.8	0.28~2.15	0.33~2.5	0.38~2.90	0.49~3.80	0.49~3.80	0.65~4.84
Rated input current (A)	0.61~4.83	0.83~5.98	0.96~7.13	1.13~7.83	1.22~9.32	1.44~10.9	1.66~12.7	2.15~16.53	0.71~5.51	0.95~7.01
Sound level at 10m dB(A)	16.5~26.0	16.8~26.1	16.6~27.9	20.1~28.7	19.3~32	21.1~31.8	18.9~32.2	21.5~32.9	21.5~32.9	20.6~32.6
Advised water flux (L/min)	40-60	40-60	50-70	60-80	75-100	100	120	130-170	160-200	220-250
Water connection (mm)	40									

### Remarks:

This heat pump is able to perform normal within air temp  $-10^{\circ}\text{C} \sim +43^{\circ}\text{C}$ , efficiency will not be guaranteed out of this range. Please take into consideration that the pool heater performance and parameters are different under various conditions.

Related parameters are subject to adjustment periodically for technical improvement without further notice. For the most up to date details please refer to nameplate on the heat pump.



## 7. Dimensions

---

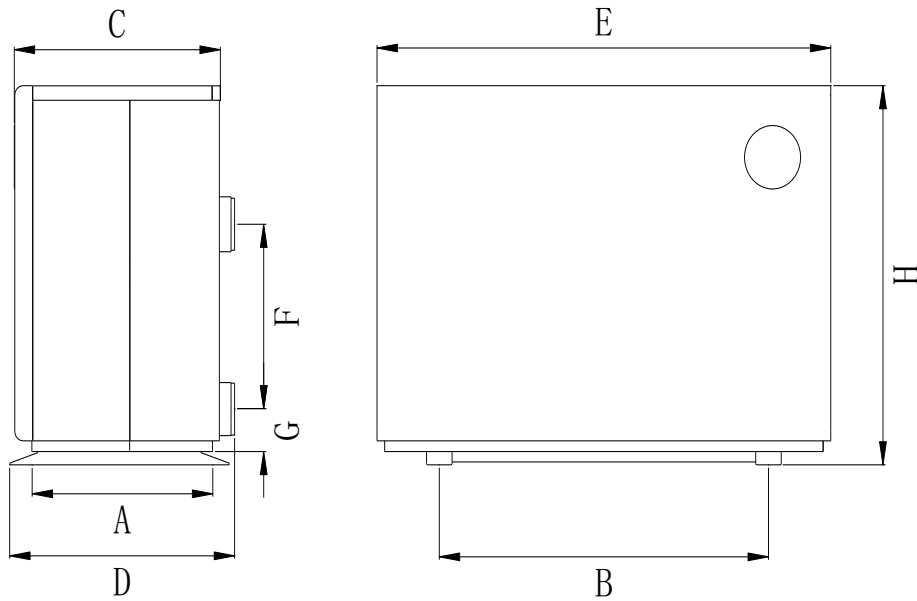

Size(mm) Name Model	A	B	C	D	E	F	G	H
ES110/ 240MM	410	645	404	440	890	290	75	658
ES130/ 240MM	410	645	404	440	890	280	75	658
ES170/ 240MM	410	710	404	440	1060	320	75	658
ES210/ 240MM	410	710	404	440	1060	460	75	758
ES280/ 240MM	410	710	404	440	1060	640	75	958
ES350S/ 400MM	492	950	486	512	1314	650	75	958

※ Above data is subject to modification without notice.

Note: The picture above and the specification diagram of the pool heater is for the technician's installation and layout reference only. The product is subject to adjustment periodically for improvement without notice.

## C. Installation

### 1. Installation requirements

Only competent persons are authorized to install the heat pump and should be educated with the relevant building codes and standards of their current state or local governing body for all electrical, mechanical and water services to prevent danger or damage to the unit.

#### a. Location and clearances

- See appendix for further ventilation scenarios



The inverter pool heat pump should be installed in a well-ventilated place.

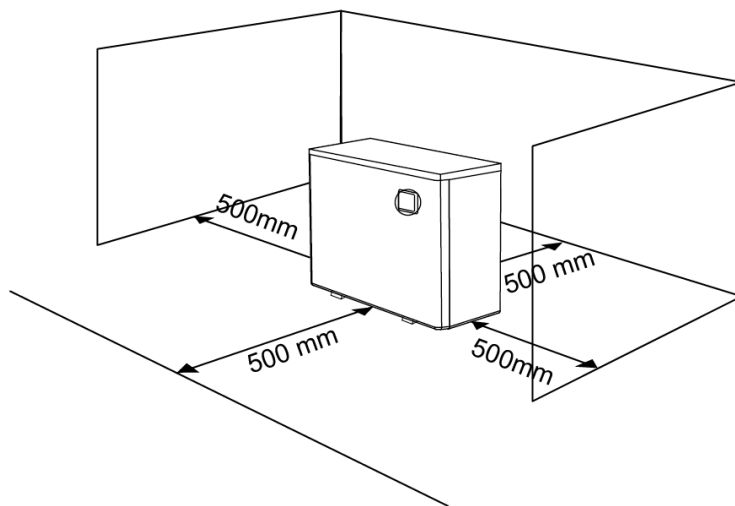

#### b. Typical installation diagram

Installations can differ dependent on-site conditions below is only a representation of one possibility. Note: the inlet and outlet positions for the pipework is a representation only and can be positioned differently

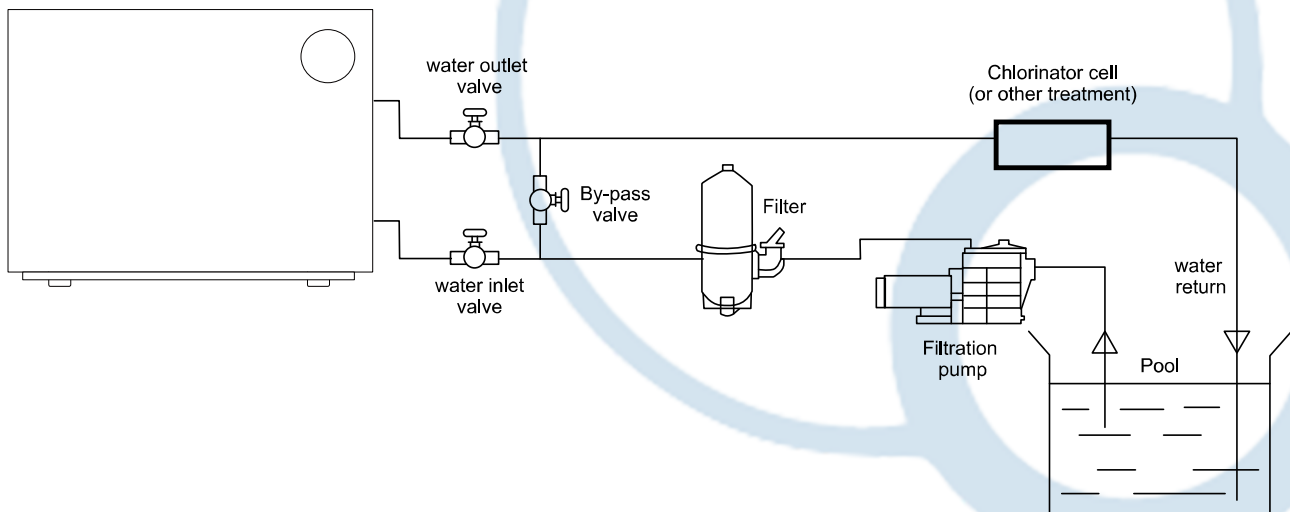

## 2. Placing the unit and water connections

---

### a. Placing the unit and fixing

- The frame must be fixed by bolts (M10) to a concrete foundation or brackets. The concrete foundation must be solid and fastened; the bracket must be strong enough and anti-rust treated.
- Do not stack substances that will block air flow near the inlet or outlet area, and there should be no obstruction within 50cm behind the machine. Suffocation of air reduces the efficiency of the heater and could damage the unit.
- The machine may need an additional pump (not supplied). The recommended pump must adhere to the specification-flux of the machine, please refer to the technical parameters.

### b. Water connections and condensation

- The inlet and outlet water unions should not be installed with soft flexible pipes. The heat pump **must** be connected with rigid pipes!
- When the machine is running, condensation is created and discharged from the bottom. Please place the drainage nozzle (accessory) into the hole and clip it well, then connect a pipe to drain the condensation water away.

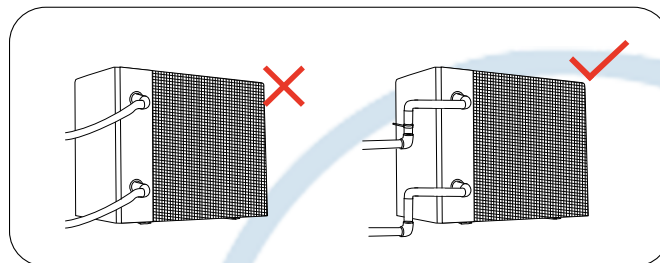

## 3. Wiring requirements

---

- a. Connect the heat pump to an appropriate power supply, the voltage should comply with the rated voltage of the product.
- b. The machine **must** be earthed
- c. Wiring must be handled by a professional technician according to the circuit diagram.
- d. Install electrical protection device according to local code for wiring
- e. The layout of power cable and signal cable should be orderly and not affecting each other.

#### 4. Electric wiring Diagram

##### a. For power supply: 230V 50Hz

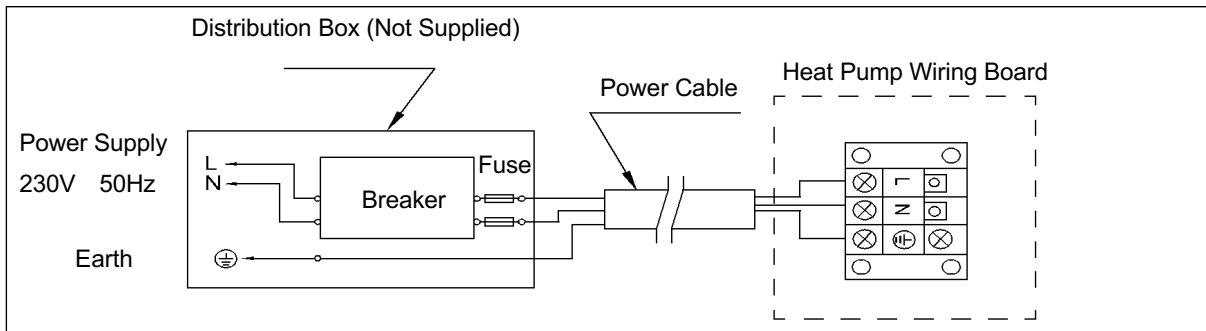

##### b. For power supply: 400V 50Hz

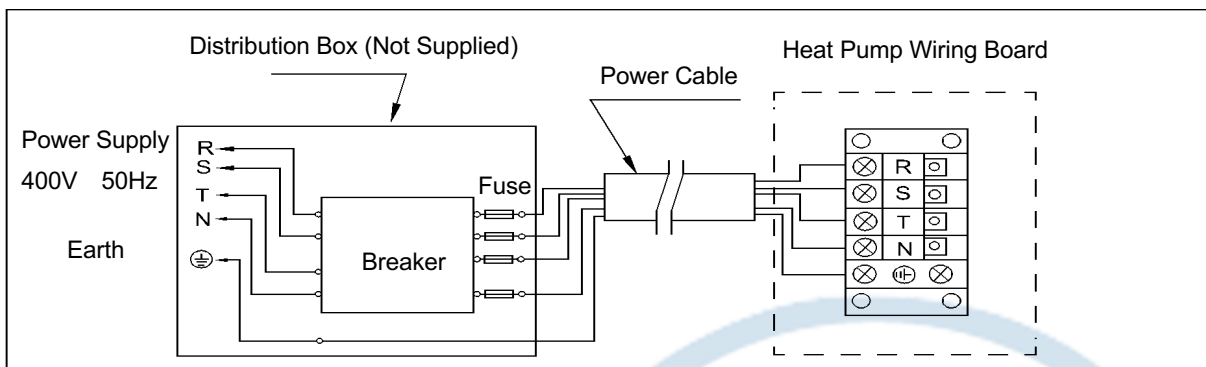

Attention: The pool heat pump must be earthed.

#### 5. References for protection devices and cable specification

MODEL		ES110/ 240MM	ES130/ 240MM	ES170/ 240MM	ES210/ 240MM	ES280/ 240MM	ES280S/ 400MM	ES350S/ 400MM
Breaker	Rated Current A	12	14.5	18	21	24	9	12
	Rated Residual Action Current mA	30	30	30	30	30	30	30

Above data is subject to modification without notice.

**Note:** The above data is associated to power cables less than 10m. If the power cable is longer than 10m, the wire diameter must be increased in accordance with current regulations. The signal cable can be extended to a maximum of 50m.

**Please see appendix for further wiring information including pump control and auxiliary input**



## 6. Installation options

---

### a. Flow switch activated heating

The heat pump is activated by the flow of water initiated from the filtration circulation pump, if the heater gets to temperature within the timers the unit will first start to use the inverter technology to slow the machine down to maintain the temperature and eventually to a stop.

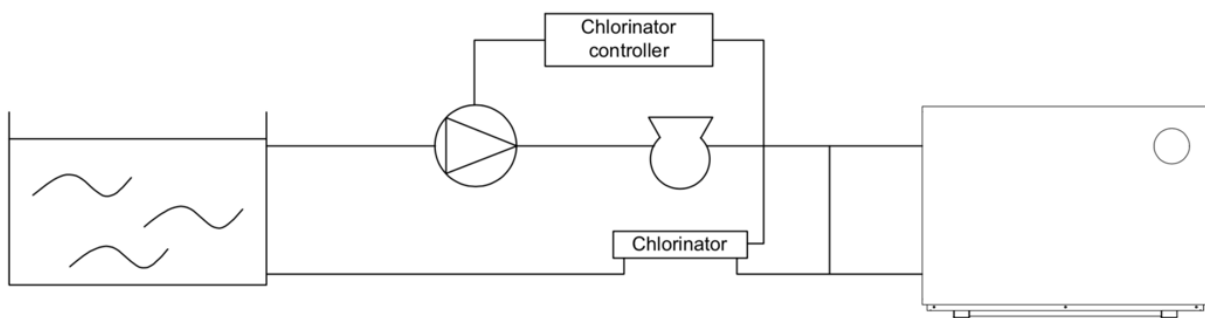

- 1- Chlorinator controller initiates the filtration pump.
- 2- Heat pump's flow switch senses the water flowing through the heat pump.
- 3- Heat pump starts and will run until temperature is reached or filtration pump switches off
- 4- No additional internal wiring to the heat pump is required in this set up
- 5- No additional settings needed to be changed
- 6- If circulation pump is not running and no flow is detected unit will display E3 – this is normal and an indication the unit is sitting idle waiting for the filtration pump to start again.
- 7- If the pool temperature is not reached within the filtration times you may need to extend the timers to match the heating requirement.

**b. Heat pump activation without using the chlorinator controller and using the one pump used for filtration (additional controller required)**

An on board pump output relay can activate the main filtration pump by using it in combination with a single pump controller without using the chlorinator timers needing to be activated which will stop over chlorination but still use a single supply pipework for the pool. This set-up is best when only single pipework is available from pool and doesn't have individual heating pipework. Efficient with only one pump working.

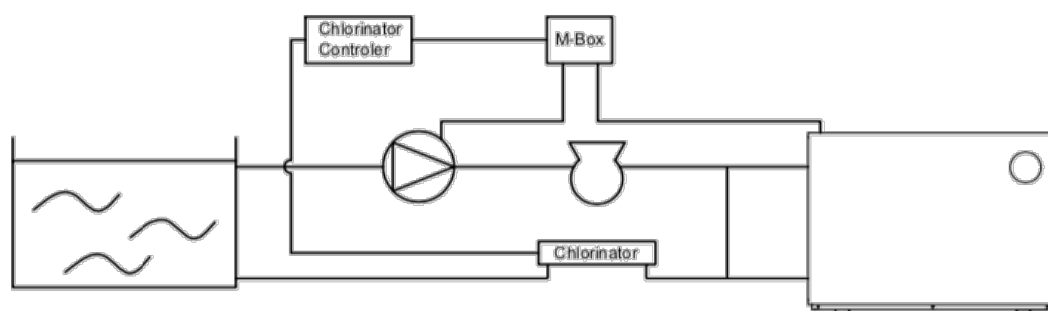

- 1- The pump output switch relay labelled P1 – P2 in the heat pump can activate the filtration pump through the single pump controller (MJ-Box), therefore being able to run the heat pump individually with the same pump
- 2- Relay switch P1 – P2 are initiated as soon as the heat pump is turned on, the output will run the circulation pump until the heated water reaches the set temperature or is switched off by the WiFi timers.
- 3- If the unit reached temperature still within the timer set points, the unit will test the water by starting the filtration pump once an hour for 2 minutes to get an accurate temperature reading and will start heating process again if required.
- 4- When Wi-Fi timers are set through the app Relay switch will run the pump output accordingly.
- 5- Timers for the heat pump are on the Wi-Fi app (If no WiFi available additional timer may be required) internal setting require changing to suit this operation.
- 6- See electrical diagram supplied with M-box for further information.

### c. Individual circulation pump installation.

An onboard output initiates the circulation pump to start and stop from the heat pump itself based on temperature and timers. For use when there are dedicated heating pipes and to separate from the filtration timers.

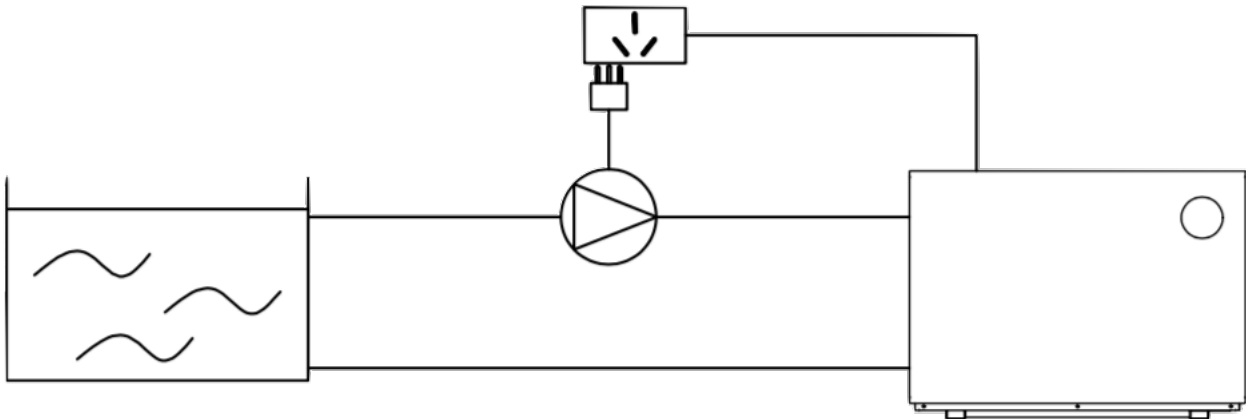

- 1- Termination points are labelled P1-P2 from the on board relay and is activated by the timers and pool temperature, and will continue to run the pump until the heated water reaches the set temperature or the timer switches off.
- 2- Once temperature is reached or the timer is finished the heat pump will switch off the relay output stopping the circulation pump.
- 3- If the pool reaches temperature but the timer is still active the heat pump will switch off relay to stop the circulation pump. Whilst the timer is still active every hour it will run the circulation pump for 2 minutes to test the water temperature. If the temperature is 1 degree below set point the heat pump will continue to run the circulation pump and start the heating process again.
- 4- P1 – P2 relay up to 10A output for circulation pump (check total load on circuit when combined) (P1 and P2 is an output relay switch not active neutral terminals, please see wiring diagram for further information).
- 5- Heat Pump timers are set through the mobile application and required a WiFi connection. If no WiFi is present then additional external timer may be required (sold separately)
- 6- It is recommended to install a power point for the pump to plug into for any future service work to the pump which may be required.
- 7- Circulation pump should be sized accordingly to suit the site conditions and flow required.

#### d. Solar retro

In some situations, when a heat pump is replacing a solar heating system, the pipework is available to be used next to the house but there is no way of adding a new electrical circuit to the pool equipment. With the use of an additional temperature sensor you can use the in-built flow switch to activate the heating. Allowing you to use the existing solar pump and to install the heater closer to the switch board.

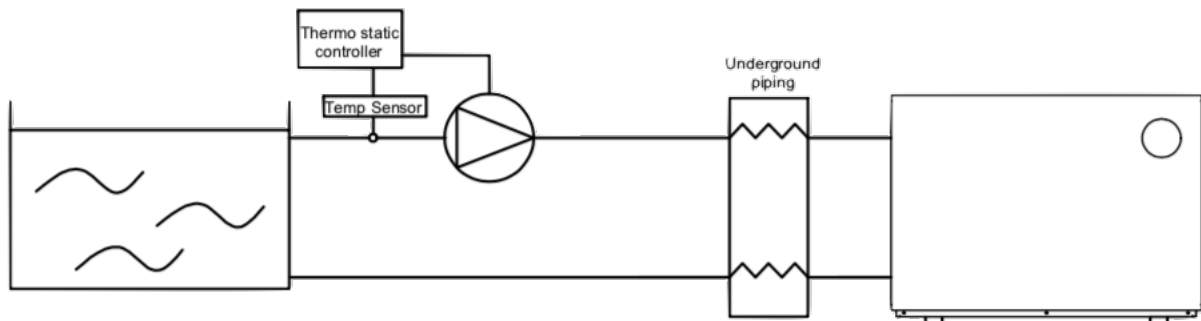

- 1- It may be impractical to get a new power cable from the house switch board to the pool equipment area due to finished flooring etc, in this case it may be possible to use the existing pipework which connects to the house and install a power cable from there.
- 2- An external thermostat controller can initiate the existing circulation pump, thus running the heat pump through the flow switch for full temperature control.  
Please speak to your installer for more information.
- 3- No additional wiring to the heat pump is needed internally
- 4- Timers are set on the external thermostatic controller
- 5- Set heat pump a couple of degrees above the set point temperature of the external temperature controller.

#### e. Automation system

The heat pump comes with easy-to-connect terminals in the electrical compartment labelled as 5 and 6. The unit comes prewired with a bridge cable connected. To add an external control to activate the heat pump, remove the bridge and add in a volt-free terminal connection. Please check with the automation system provider that the connection is volt-free and the best way to install with their set-up.









## D. Operation guidance



---

### 1. Display Functions

---



Symbol	Designation	Function
	ON/OFF	Power On/Off WiFi setting
	Unlock	Lock/Unlock Screen
	Speed Mode	Two modes: Boost  Silence 
	UP/DOWN	Temperature Setting & Displaying

- Standby mode or Screen lock: Only  symbol lights up, screen and other buttons turn darker.
- Power off mode: Only  symbol will light up, No display on screen.
- The controller has a power-saving mode and will not display bright when locked.
- The controller has a built-in memory so all parameters are saved in the event of power loss



## 2.Operation Instruction

---

### a. Screen Lock

- 1) Press  button for 3 seconds to lock or unlock the screen
- 2) Display automatically locks in no input is detected after 30 seconds.



### b. Power On

Press  for 3 seconds to unlock screen, Press  to power on machine.

### c. Temperature Setting

Press  and  to display and adjust set temperature.

### d. Mode Selection

Press  to switch between boost mode , silent mode 



Default mode is Boost 

Please choose boost mode  for initial heating

### e. WIFI

Download InverGo app from Apple app store or Google Play store.

Set up new account, enter WiFi password and click add new device (Enter area code +61 when registering by phone number)



When the screen is unlocked, hold  button for 3 seconds, after  symbol will begin flashing.

WiFi connection process has now started on the unit.

Now press Bind Device on mobile device.

System should now have connected within the minute and now enjoy controlling the unit through WiFi.

When WiFi is connected  symbol is displayed.

To clear the WiFi setting history on machine. When the screen is on, press and hold  for 10 seconds,  symbol will flash fast for 10 seconds then switch off.

#### d. Defrost cycle



- Automatic active defrosting

When the machine is operating in low temperatures it is very common for ice to build up on the external coil. The heat pump has a built in defrost protection program which will activate when it senses ice starting to form.

When machine is defrosting, ☀️ starts flashing; after defrosting ☀️ is on continuously

- Forced defrosting,

If the heat pump requires manually defrosting for testing or a sensor is faulty please follow these instructions, the machine must be in heating mode and the compressor is working continuously for

more than ten minutes, Whilst the unit is running, press  and  on the

controller simultaneously and hold for 5 seconds. When the ☀️ symbol is flashing, defrost has started, and will continue until the external coil temperature reaches a certain temperature adequate for continued operation. If the ☀️ symbol stops flashing forced defrost has stopped.

\*Note: the interval between forced defrosting should be more than 30 minutes apart.



## E. Testing

### 1. Heat pump checks before use

- The air inlets and outlets are free of any debris and are not obstructed.
- Refrigeration pipes or components are not installed in a corrosive environment.
- Check electric wiring connections are tight and adhere to the electrical schematic
- Check for water leaks around the machine and all new water connections





### 2. Refrigerant leak detection

- Leak testing is prohibited in enclosed areas
- Any source of ignition is prohibited during leak checks.
- Leak detection fluids can be used with most refrigerants but the use of products containing chlorine should be avoided as the chlorine may react with the refrigerant and corrode the copper pipe.
- Vacuum the machine completely before welding. Welding should only be carried out by a professional person in a service center.
- Please stop immediately if a gas leak occurs, and contact your local service center.

### 3. Trial Run

- The circulation pump must start before the heat pump and stop after the heat pump to avoid any damage occurring to the machine.
- In order to protect the heat pump, the machine is equipped with a time lag start function, the fan will run 1 minute earlier than the compressor when starting the machine, and it will stop running 1 minute later than the compressor when power off the machine.
- After the heat pump starts, check for any abnormal noises from the machine.

### 4. Running status check

- Press and hold  for 5 seconds, a beep sound should be heard and it will enter into running status mode
- Use  and  to switch through the different values
- Press  again to quit can running status mode

**Running status codes and corresponding values**

Symbol	Content	Unit
C0	Inlet water temp	°C
C1	Outlet water temp	°C
C2	Ambient temp	°C
C3	Exhaust temp	°C
C4	Outer coil pipe temp	°C
C5	Gas return temp	°C
C6	Inner coil pipe tem	°C
C9	Radiator temp	°C
C10	Electronic expansion valve opening	P

## F. Commissioning

---

### 1. Flow Rates

Each Pool Heat Pump has a minimum flow rate requirement please check the specification table water flux section to ensure the circulation pump in use is adequately sized.

Calibrating the flow rate.

By using the running status function on the touch controller, it is easy to calibrate the check valves installed for optimum flow rates through the heat pump.

#### **OPTIMUM FLOW RATE DIFFERENTIAL FROM INLET TO OUTLET IS BETWEEN 2-3 DEGREES**

Madimack Heat Pumps have a built-in flow switch which will deactivate the heating function if not enough water flow is detected. The Heat Pump has a large range operation up to a seven-degree differential. If the temperature differential is above 7 degrees, the built-in flow switch or E6 Error will be displayed indicating not enough flow detected.

Recommended procedure

- a. Fully open all valves including the by-pass and switch the unit on to max temp.
- b. If Error E3 is displayed slowly close by pass valve until unit initiates.
- c. Wait 3-4 minutes until heat pump is at 100% Capacity
- d. Check inlet and outlet temperature through on-screen controller running status check
- e. Open the by-pass valve to increase temperature differential
- f. Close the by-pass valve to decrease temperature differential
- g. Once optimum temperature achieved lock position of by-pass if possible.

#### **Checklist**

- Unit has been installed level
- Minimum 500mm around and above unit for access and ventilation requirements are correct to standards show in appendix K
- Condensation drain pipe has been connected and drains away from unit
- Rubber feet have been placed underneath unit
- Warranty registration details have been filled out in section L

## G. Maintenance

---



**“SWITCH OFF”** power supply to the heater before cleaning, examination or

1. In the winter season when unit is not operating for long periods of time or if prone to freezing.
  - a. Switch off all power supply to prevent any machine damage.
  - b. Drain water completely from the machine.
  - c. Cover the machine body when not in use.

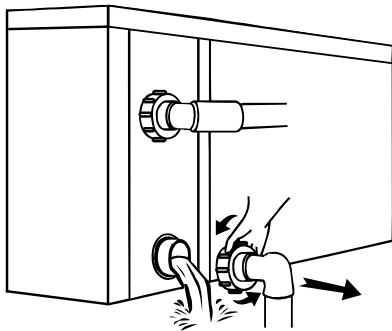

**!!Important:**

Unscrew the water nozzle of inlet pipe to let the water flow out.

*When the water in machine freezes in winter season, the titanium heat exchanger may be damaged.*

2. Only clean this machine with household detergents or clean water, NEVER use gasoline, thinners or any similar fuel.
3. Check bolts, cables and connections regularly.
4. If repairs or removal is required, please contact an authorized service center.
5. Do not attempt to work on the equipment by yourself. Improper operation may cause danger.
6. To reduce risks, safety inspections must be carried out before the maintenance or repairing for heat pumps with R32 gas.



## H. Trouble shooting for common faults

---

### 1. Repairing Guidance

---



**WARNING:**

If repairs or removal is required, contact authorized service center.

#### Requirements for Service Personnel

- a. Any person who is involved with working on or breaking into a refrigerant circuit should hold a current valid certificate from an industry-accredited assessment authority, which authorizes their competence to handle refrigerants safely in accordance with an industry recognized assessment specification.
- b. Do not attempt to work on the equipment by yourself. Improper operation may cause danger.
- c. Strictly comply with the manufacturer's requirements when charging R32 gas and equipment maintenance. This chapter focuses on special maintenance requirements for swimming pool heat pump with R32 gas. Please refer to the technical service manual for detailed maintenance operation.
- d. Vacuum system completely before welding. Welding should only be carried out by professional person in a service center.

### 2. Problems without an error code

---

Failure	Reason	Solution
<b>Heat pump doesn't run</b>	No power	Wait until the power recovers
	Power switch is off	Switch on the power
	Fuse is broken	Check and change the fuse
	The breaker is off	Check and turn on the breaker
<b>Fan running but with insufficient heating</b>	Evaporator blocked	Remove the obstacles
	Air outlet blocked	Remove the obstacles
	3-minute start delay	Wait patiently
<b>Display normal, but no heating</b>	Set temperature too low	Set proper heating temp.
	3-minute start delay	Wait patiently
If above solutions don't work, please contact your installer with detailed information and your model number. Please don't try to repair it yourself.		

**Note:** If the unit frequently breaks the circuit breaker, please stop the machine immediately by switching off the main power and contact your dealer or local repair centre.

1. The fuse is frequently broken
2. Leakage circuit breaker activated

## Protection & Failure code

Error	Component corresponding	What did the error detect?	Solution
E1	High pressure protection	High water flow pressure switch	Check the water flow from the filtration pump, check the sensor electrical connection, might need to change if faulty, check the pressure switch and circuit
E2	Low pressure protection	Low water flow pressure sensor	Check the water flow from the filtration pump, check the sensor electrical connection, might need to change if faulty, check the pressure switch and circuit
E3	No water protection	Low water flowrate	Check the water flow in pipes, and filtration pump Check the Water flow switch
E4	3 phases sequence protection	Electrical power connection	Check the power connection to the pump
E5	Power supply excesses operation range (Not failure)		1). Recover when back to the normal power 2). Replace PCB
E6	Excessive temp difference between inlet and outlet water (Insufficient waterflow protection)	High temperature difference	Check the water flow in pipes, and filtration pump Check the Water flow switch
E7	Water outlet temp too high or too low protection	Water flowrate in pipes	Check if there is any blockage in the inlets, outlets, and through the pipe
E8	High exhaust temp protection	Compressor overheating	Check if refrigerant gas is leaking, check the connection of the sensor, might need to change if faulty, check the compressor of the pump
Eb	Ambient temperature too high or too low protection (not failure)	Out of the heat pump's capacity to withdraw heat from the atmosphere	Out of application range
Ed	Anti-freezing reminder (not failure )		Wait for automatic recovery
F1	Compressor drive module failure	Lack of phase	Check the voltage and the frequency conversion
F2	PFC module failure	PFC circuit	Check the PFC switch circuit if short or not
F3	Compressor start failure	Compressor circuit	Check the compressor wiring if its correct or if there is any short circuit
F4	Compressor running failure	Compressor circuit	Check the compressor wiring if its correct or if there is any short circuit
F5	Inverter board over current protection		1). Wiring 2). Inverter board 3). PCB
F6	Inverter board overheat protection	Inverter board high temp	Check the current flowing it might need to



<b>F7</b>	Current protection		1). Power off and restart 2). Inverter board 3). Compressor
<b>F8</b>	Cooling plate overheat protection		1). Power off and restart 2). Check fan motor 3). Check cooling plate
<b>F9</b>	Fan motor failure	Fan motor	Check the fan motor wiring, check if the fan is broken or loose
<b>Fb</b>	Power filter plate No-power protection	Power filter not working	Single Phase Model 1). Replace Inverter board 3 Phases Model 1). Replace power filter plate
<b>FA</b>	PFC module over current protection	Solar inverter voltage change Power black out Power surge	1). Initial power testing has completed. Power off and restart (happens install with solar PV) 2). Replace Inverter board
<b>P1</b>	Water inlet temp sensor failure	The water inlet temperature sensor is either damaged or running a short circuit	Check the Temperature sensor at the water inlet, might need to be changed
<b>P2</b>	Water outlet temp sensor failure	The water outlet temperature sensor is either damaged or running a short circuit	Check the Temperature sensor at the water outlet, might need to be changed
<b>P3</b>	Gas exhaust temp sensor failure	The sensor is running a short circuit, damaged, or not fixed properly	Check the gas exhaust Temperature sensor, might need a replacement
<b>P4</b>	Evaporator coil pipe temp sensor failure	The sensor is running a short circuit, damaged, or not fixed properly	Check the evaporative coil pipe Temperature sensor, might need a replacement
<b>P5</b>	Gas return temp sensor failure	The sensor is running a short circuit, damaged, or not fixed properly	Check the Gas return Temperature sensor, might need a replacement
<b>P6</b>	Cooling coil pipe temp sensor failure	The sensor is running a short circuit, damaged, or not fixed properly	Check the cooling coil pipe Temperature sensor, might need a replacement
<b>P7</b>	Ambient temp sensor failure	The sensor is running a short circuit, damaged, or not fixed properly	Check the Ambient Temperature sensor, might need a replacement
<b>P8</b>	Cooling plate temp sensor failure	The sensor is running a short circuit, damaged, or not fixed properly	Replace inverter board
<b>P9</b>	Current sensor failure	The sensor is running a short circuit, damaged	1). Replace inverter board for single phase model 2). Replace power filter plate for 3 phases model

# I. Appendix

## Water Pump: 230V voltage & less than 10A

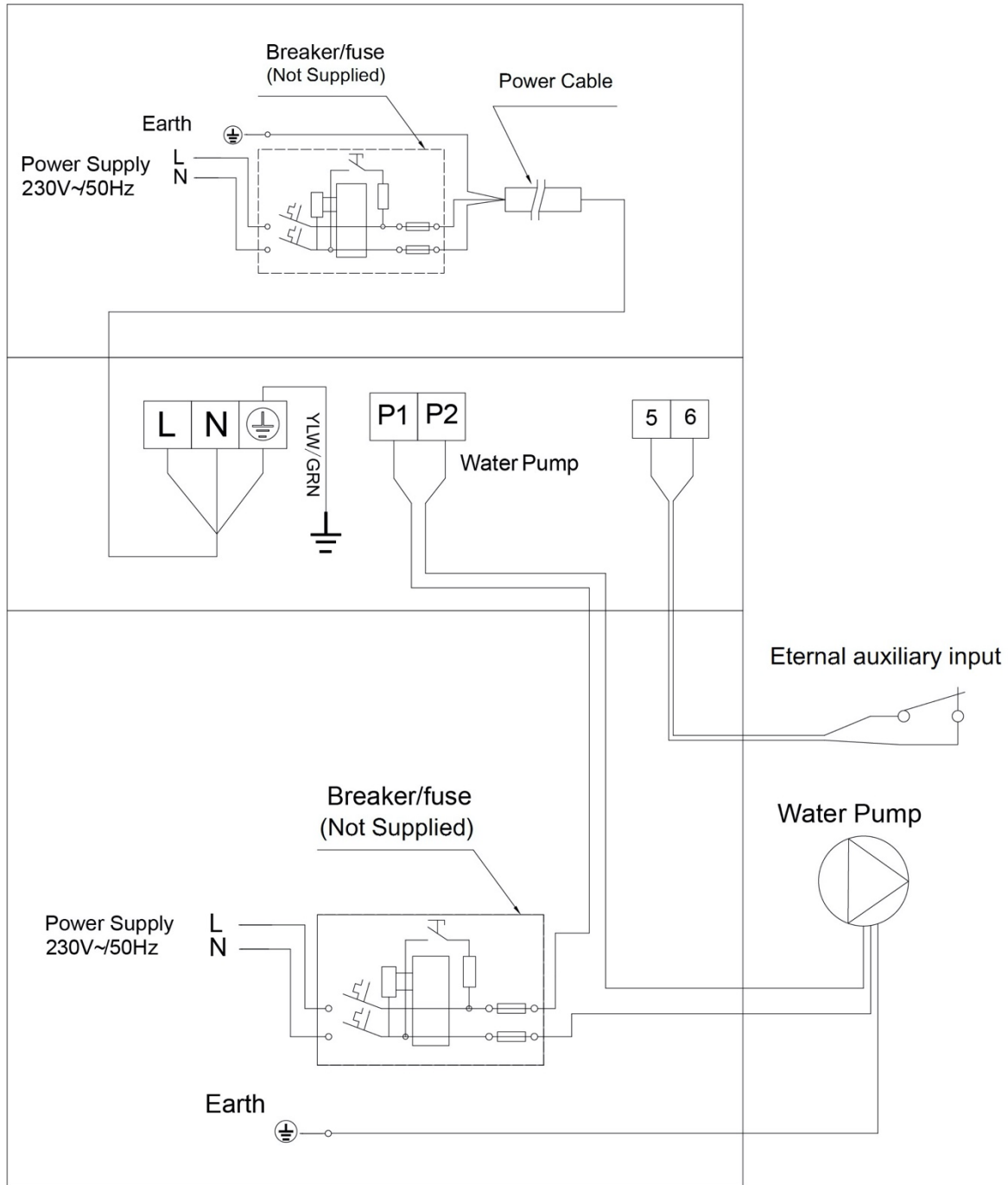

# Water Pump: 230V voltage & more than 10A

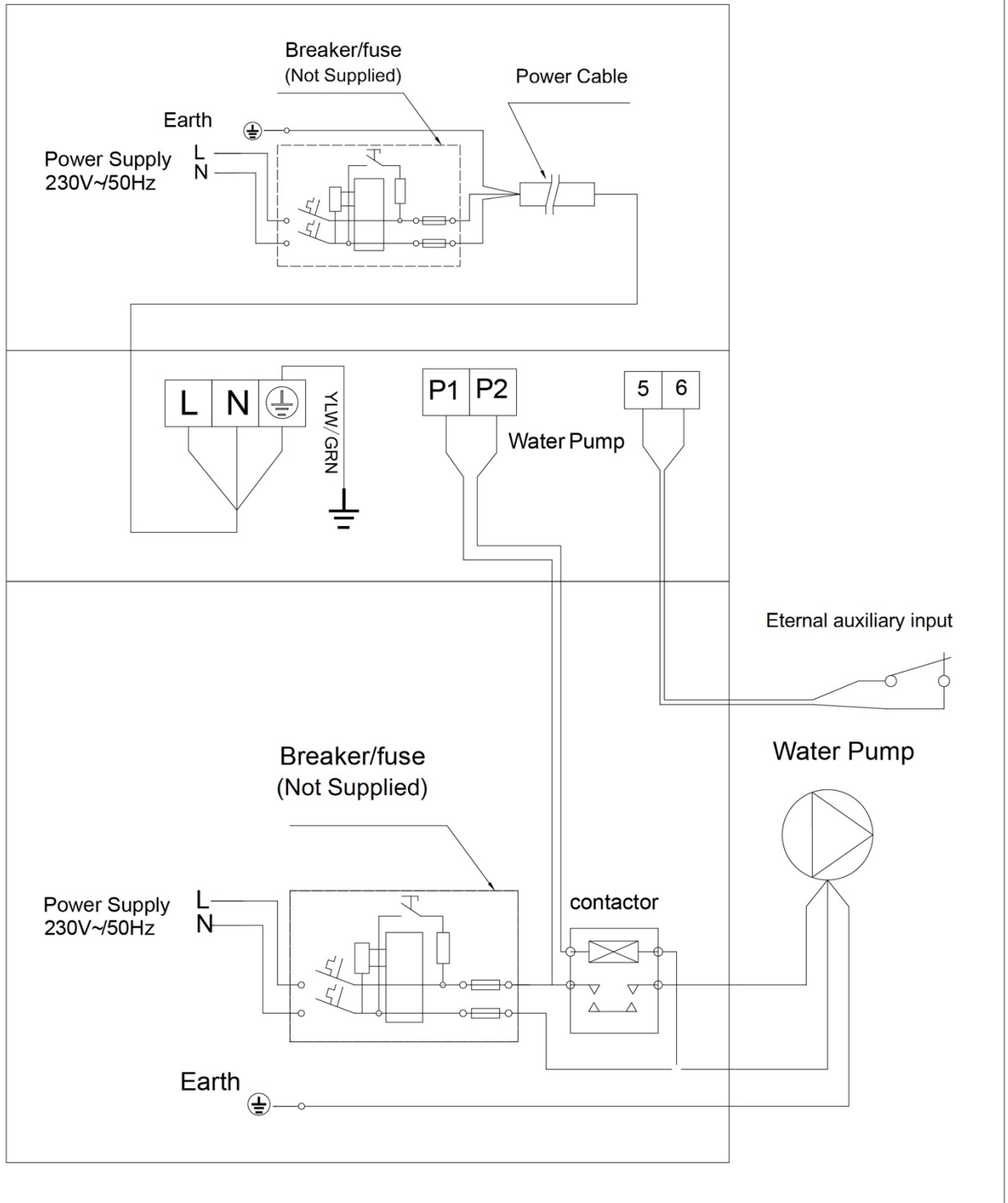

# Water Pump: 400V voltage

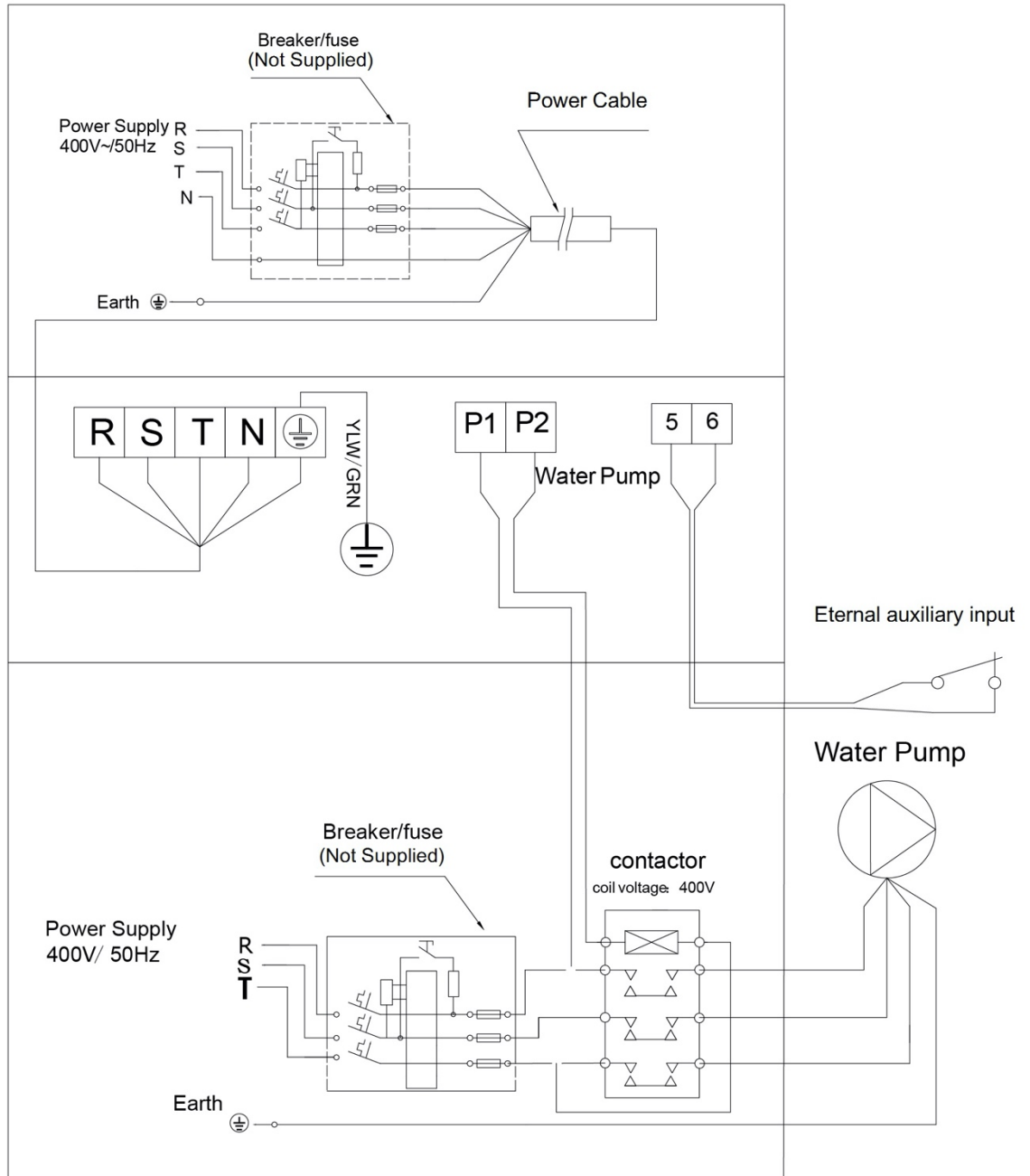

## Water pump control and timer connection

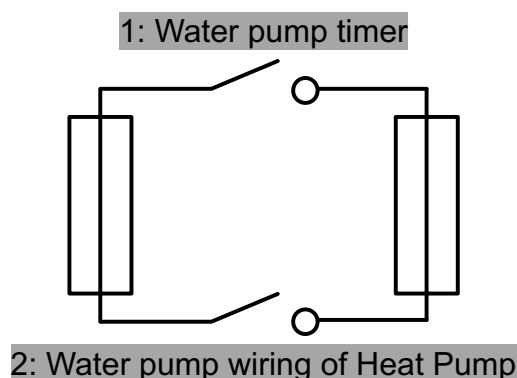

Note: The installer should connect 1 parallel with 2 (as above picture). To start the water pump, condition 1 or 2 is connected. To stop the water pump, both 1 and 2 should be disconnected.

## Water Testing Pump Output

For an individual pump system only used for pool heating.

The heat pump is fitted with a smart controller output which allows water testing to occur after a set period of time after the heat pump has reached temperature. This can be activated through the internal settings but is not set as default.

E.G the pump runs every hour for 3 minutes to test the water temperature, if the temperature is below set point the pump will continue to run and heat the pool, when the temperature is achieved the heat pump and pump will switch off and testing time will begin again.

For further information please contact your sales representative.

## External input

Some units come with a built-in external input labelled 5 and 6. This comes standard as a looped connection and is used for an external signal.

This is a volt free contact and with continuity through connections 5 and 6 it will signal the unit to operate. Note. It will only activate if the timers are activated in parallel with the input.

This external input allows the system to run with most automation systems or in combination with solar systems where there is a priority heat source.

For more information please contact your local sales representative or contact technical sales

## J. Wi-Fi operation

For video tutorials and further help please visit [www.Madimack.com.au](http://www.Madimack.com.au) FAQ for all you need to do and full walkthrough. It is crucial that the WiFi is over the machine and is of a high power, the WiFi is a cloud based solution and needs the WiFi to be active on the machine for it to receive a signal.

### 1 APP Download



Android please download from



iOS please download from



### 2 Account Registration

1. Register by mobile or E-mail.

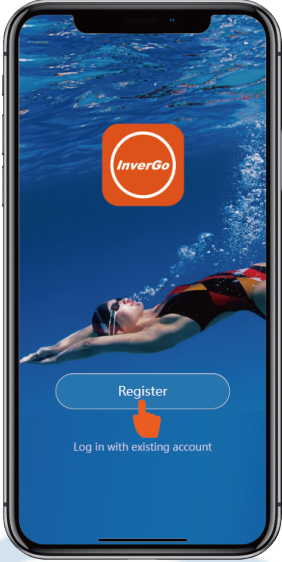

2. Mobile or E-mail registration.

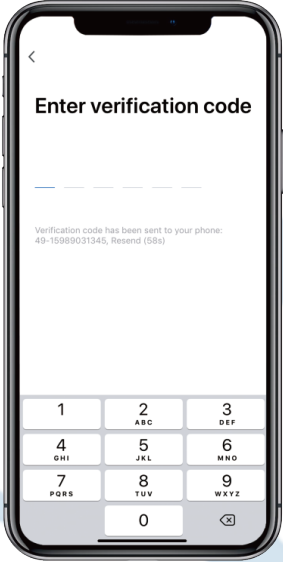
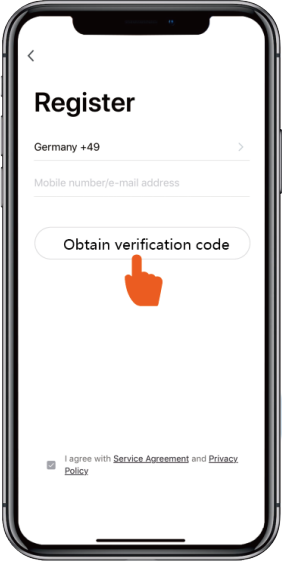

### 3 Create Family

Please set family name and choose the room of device.

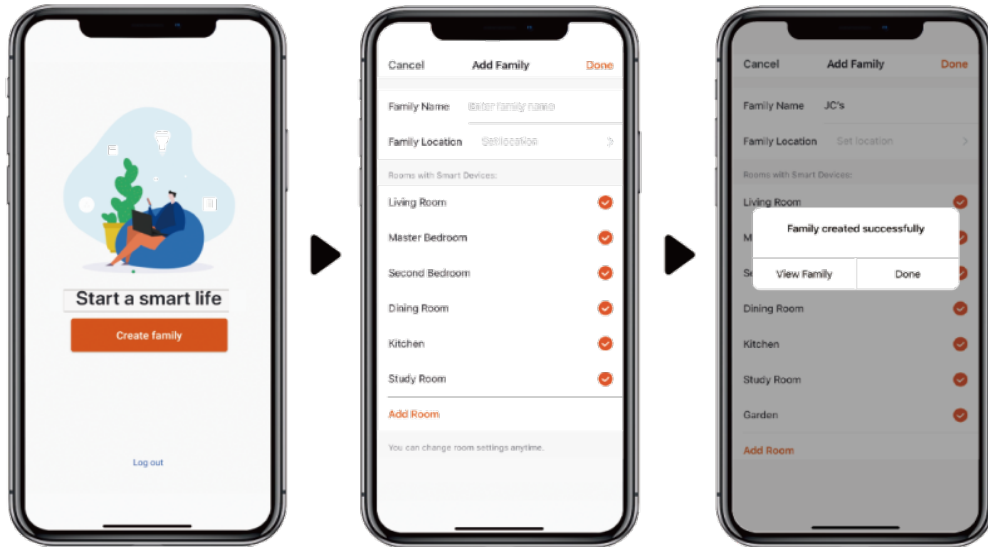

### 4 APP Pairing

Please make sure you are connected to the Wi-Fi.

1. Press “ M” for 3 seconds to unlock the screen, press “ ” for 3 seconds then release, after hearing “Beep”, enter Wi-Fi password in APP. During connection, “ ” flashes, when the APP connects to the Wi-Fi successfully, “ ” will display.



## 5 Operation

1. For heat pump with Heating function only :



2. For heat pump with Heating&Cooling function :





## 6 Share Devices to Your Family Members

After pairing, if your family members also want to control the device. Please let your family members register the APP first, and then the administrator can operate as below:

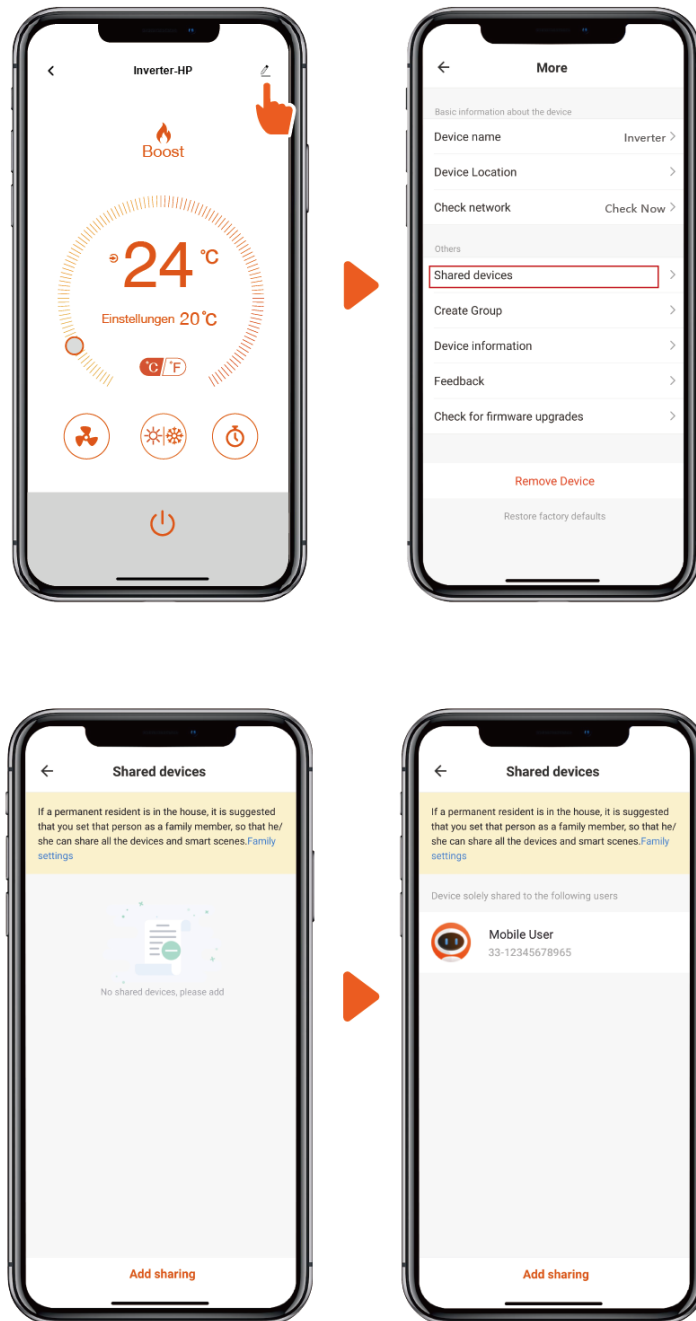

Notice:

1. If Wi-Fi signal can not cover the device (Normally 10m-15m), please connect 10m extension cable (optional, not standard configuration).
2. The weather forecast is just for reference.

App is subject to updating without notice.

2. Click "Add Device", and then follow instructions to pair device.

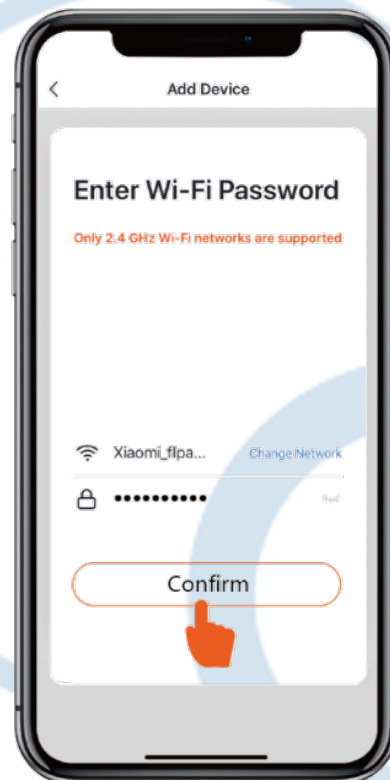
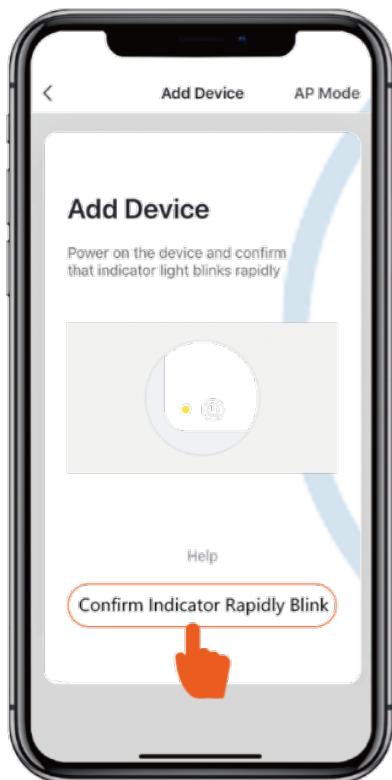
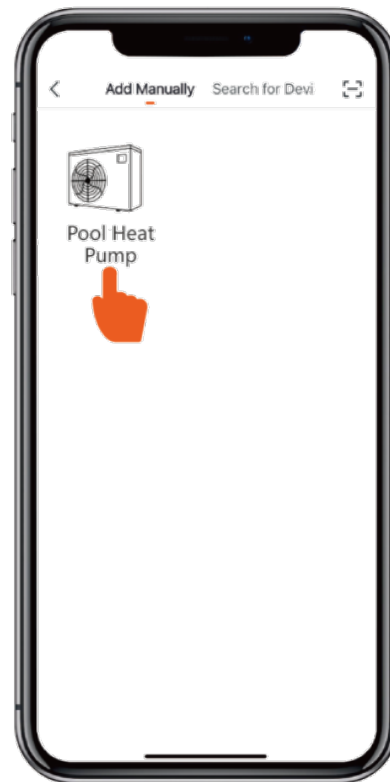
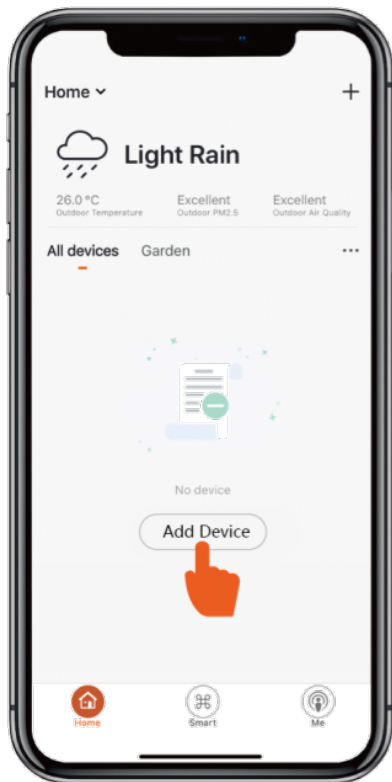

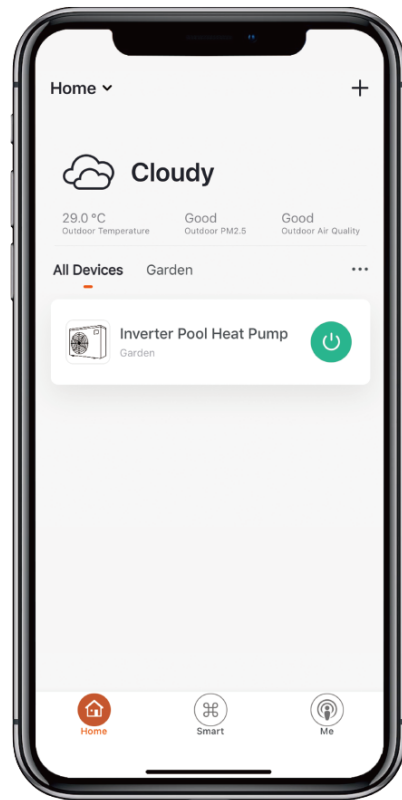
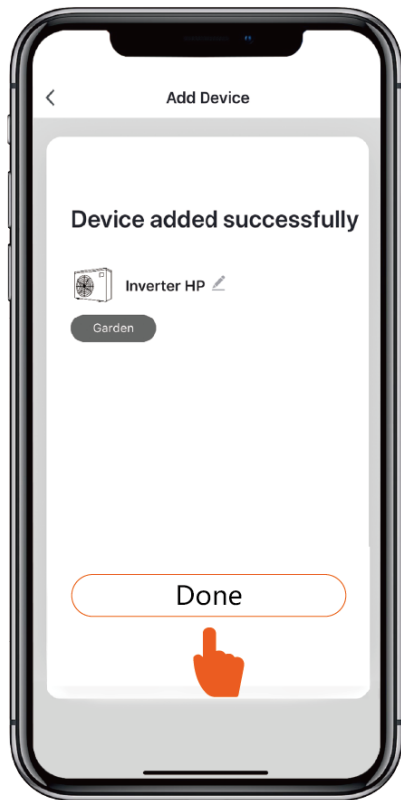
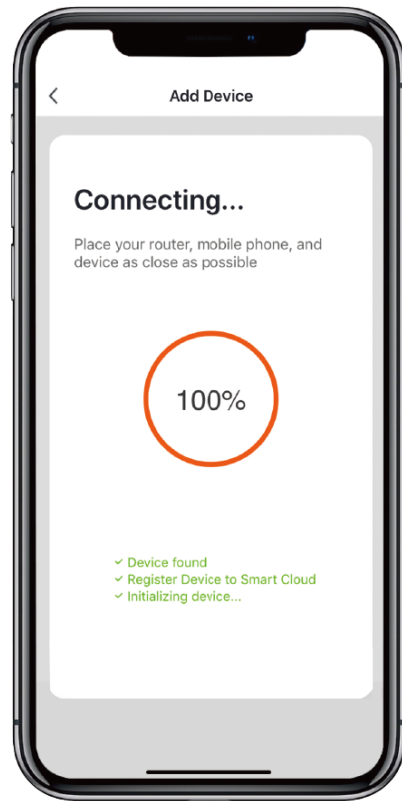
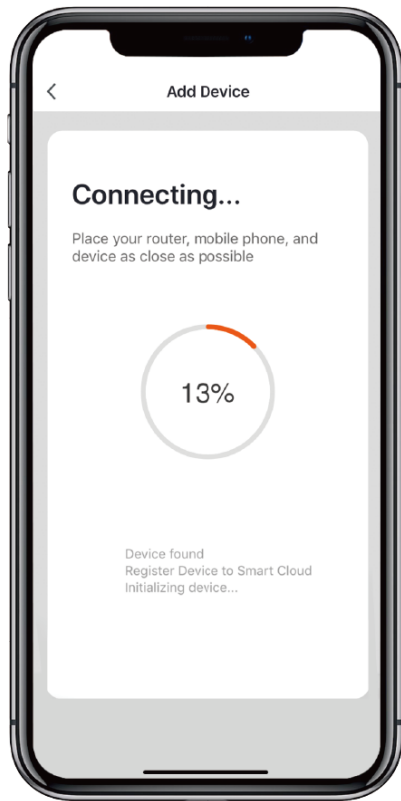

## K.Ventilation

### Heat pump ventilation requirements with other scenarios

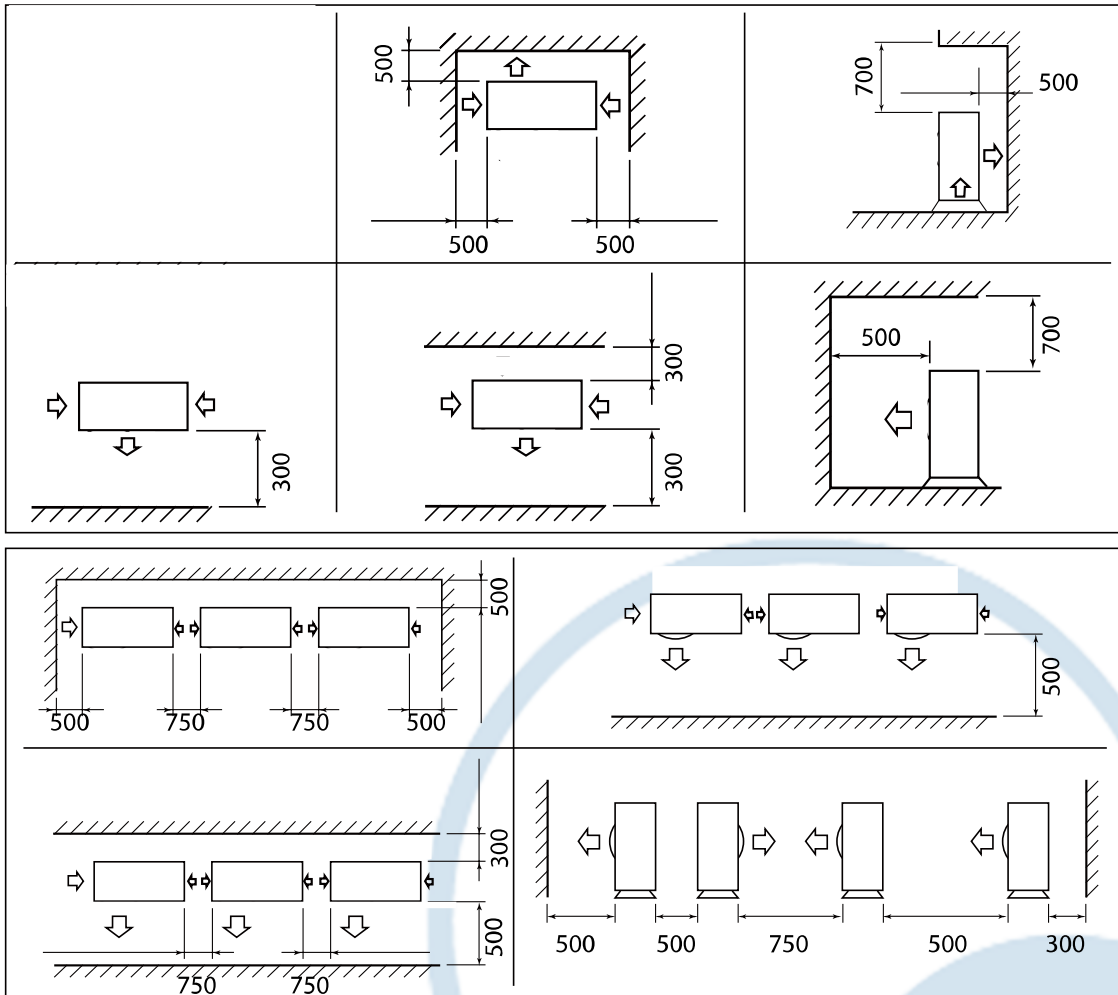

# Heat Pump Warranty Agreement

This Warranty applies to domestic and commercial products purchased and installed in Australia.

*Our goods come with guarantees that cannot be excluded under the Australian Consumer Law. You are entitled to a replacement or refund for a major failure and for compensation for any other reasonably foreseeable loss or damage. You are also entitled to have the goods repaired or replaced if the goods fail to be of acceptable quality and the failure does not amount to a major failure. Your Australian Consumer Law guarantees, and similar statutory rights, are called the “Owner’s Statutory Rights” in this Warranty.*

**THE RIGHTS GIVEN BY MADIMACK AUSTRALIA WARRANTY ARE IN ADDITION TO THE OWNER’S STATUTORY RIGHTS.**

---

The Madimack [Pty Ltd \("Madimack"\)](#) equipment listed on the back of this card is warranted by Madimack against defects in design, materials and workmanship for a period of up to 4 Years from the date the equipment is purchased by the original owner.

Equipment defects covered by this Warranty will be repaired or replaced at the discretion of Madimack (subject to the Owner's rights under the Australian Consumer Law with respect to major failures) without cost to the owner for parts or direct repair labour. The repair or replacement shall be performed during normal business hours by Madimack or a repair agent authorised by Madimack.

Any Madimack parts or Madimack equipment replaced under this Warranty will be warranted in accordance with the provisions of this Warranty for the remainder of the original warranty period or 12 months from the completion of the repair, whichever is the greater. Except where inconsistent with the Owner's Statutory Rights and the rights given by this Warranty, all other warranties and all liability of Madimack for any loss or damage direct and consequential is expressly excluded.

**This Warranty DOES NOT cover: -**

- a) Damage or problems or unsatisfactory performance caused to the equipment by faulty or incorrect external electrical wiring, incorrect power supply, voltage fluctuations, over voltage transients or electromagnetic interference not originating within the equipment.
- b) Damage or problems resulting from incorrect or poor installation.
- c) Damage or problems caused by the use of an accessory, component or equipment not supplied by Madimack.
- d) Damage or problems caused by storm, fire, flood, vandalism, misuse, negligence, Acts of God, earthquake, war, vermin, foreign matter entering the equipment (e.g. dirt and moisture) or any other outside agency.
- e) Damage or deterioration to the external surfaces or refrigeration coils caused by normal weathering or corrosive atmospheric conditions.
- f) Any costs or additional labor associated with gaining acceptable service access to equipment installed in restricted or unsafe (e.g. high) locations.
- g) Freight charges (including insurance) or travelling cost for repairs performed outside the area normally serviced by Madimack or a repair agent authorized by Madimack.
- h) Equipment which has been installed in a transportable or mobile application (e.g. caravan or boat).
- i) Equipment which has been re-installed in a transportable or mobile application (e.g. caravan or boat).
- j) Equipment which has been re-installed at a location other than the original location.
- k) Any consumable item (e.g. batteries, filters, and belts) supplied with the equipment unless the item is shown to be defective at the time of purchase.
- l) Damage or problems or unsatisfactory performance resulting from operation in an environment where the climatic comfort of humans is not the primary function of the equipment.
- m) Damage or problems or unsatisfactory performance resulting from operations at conditions outside the operating conditions specified in the Madimack technical or sales literature applicable to the equipment.
- n) Damage, problems or unsatisfactory performance resulting from misapplication of the equipment.

Where this Warranty does not apply, the Owner's rights are limited to the Owner's non-excludable Statutory Rights.



---

## Owner's Responsibility

The owner is responsible for the correct operation and regular maintenance of the equipment as listed below. The correction of any non-product fault or problem is not covered by this warranty.

- a) Operation and maintenance of the equipment in accordance with the operating instructions.
- b) Regular cleaning of the air filter(s) and replacement where necessary.
- c) Ensuring that the air inlet and outlet on the outdoor unit is kept clear of any obstructions (e.g. dirt, leaves, plants)
- d) Ensuring that the condensate drain is kept clean.
- e) Replacement of exhausted batteries.
- f) The application of additional corrosion protection if the product is installed in a corrosive environment (e.g. Industrial pollution, sea air).

## Owner's Statutory Rights

In respect of any goods supplied under the contract which are not of a kind ordinarily acquired for personal domestic or household use or consumption, unless the owner establishes the following limitation of liability would not be fair and reasonable, the liability of Madimack for any defect of design, materials or workmanship will be limited to any of the following as determined by Madimack: -

- a) Replacing the equipment or supplying equivalent equipment;
- b) Repairing the equipment;
- c) Paying the cost of replacing the equipment or acquiring equivalent equipment;
- d) Paying the cost of having the equipment repaired.

## Making a claim

The following steps should be taken when making a warranty claim with Madimack Pty Ltd.

1. Owners experiencing issues with their system are to contact Madimack Pty Ltd service departments online portal to and provide the requested information.
2. A service agent will review the provided information and will contact you on the provided phone number to try and solve the issue
3. If the issue cannot be dealt with over the phone, owners will be supplied with details of service agent in their area
4. Owners will need to contact and deal with service agents directly in relation to the booking in and payments of works related to the service or repair of their Madimack Pool Heat Pump
5. Owners can claim reimbursement for costs of works covered under the product warranty when completed by an approved Madimack Service Agent. When making a claim, owners will need to provide the following documents
  - Proof that you are the original system owner – original invoice showing owner name and property address
  - Copy of invoice from an approved Madimack approved service agent
  - For a major defect a copy of the report for major defects from approved Madimack Service agent
  - All Service Claim Submissions will be processed and reimbursement on validated claims paid into owner nominated account within 7 business days.

---

## L. Product Purchase Warranty Registration

Please complete all the details below from the installer and store this card along with the purchase docket in a safe place.

Please take 2 or 3 photos of the installation and with this information upload them online at

<https://www.madimack.com.au/warranty-registration>

or use the barcode scanner to go direct to the page.

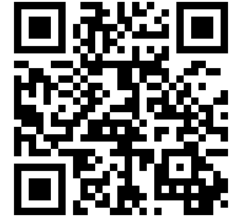

Supplied by	
Date of Purchase	
Installed by	
Installer No (if applicable)	
Date of Install	
Owners full name	
Address of Premises	
Telephone number	

Make	
Model	
Serial	
Commissioning	
By pass valve fitted?	
Temperature difference	
Notes	



---

## Warranty Period

Pool Heat Pump	Warranty			
	Series	Parts	Compressor	Labour
Summer Eco	2	3	1	25 Years
Elite Silent	4	5	1	25 Years
Eclipse	2	3	1	25 Years

IMPORTANT NOTE For repair of equipment under this Warranty it is recommended that the owner contact their Madimack Dealer / Installer. If the owner requests Madimack to perform or arrange the service call, the owner will be liable for all associated costs if the problem is not covered by the provisions of this Warranty or the Owner's Statutory Rights

For warranty claims please see [Madimack.com.au](http://Madimack.com.au) and check the technical and service section including the FAQ provided if problems are still present please fill out the online form for attention and one of our service representatives will be in touch.

[www.Madimack.com.au](http://www.Madimack.com.au)

