



Inverter Plus

INSTALLATION & USER GUIDE





INVPLUS1100, INVPLUS2200

Thank you for purchasing our variable speed pump controller.
Please read the manual carefully before installation
& operation and keep it for future reference after installation.

CONTENTS

01	IMPORTANT SAFETY INSTRUCTIONS	01
02	TECHNICAL DATA	02
03	BEFORE INSTALLATION	02
04	CONNECTING TO POOL PUMP	03
05	SETTINGS & OPERATION	04
06	PROTECTION & ERROR CODES	07
07	COMMISSIONING AND CHECKS	08
08	EXCLUSIONS	08
09	WARRANTY	09
10	RECYCLING	09

SAFETY SYMBOLS

	Read and keep the manual in a safe place
	Warning
	Caution: Risk of electrical shock
	Do not touch the heat sink
	e-Waste: Dispose at recycling centre

IMPORTANT SAFETY INSTRUCTIONS



To make the best use of this energy saving device and to avoid potential risk of fire, electrical shock, serious injury to people or damage to property, please read this user guide carefully before installation and keep it for future reference.

This device can only be used with pumps with permanent split capacitor motor. The schematic diagram below shows a typical single speed swimming pool pump motor.

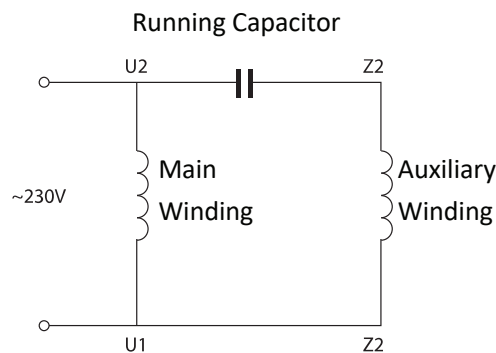

Fig 1

1.1 It is NOT compatible with:

- a. Single phase motors with centrifugal switch
- b. Pool pump motors with start relays or switch
- c. Series or DC motors
- d. Pool pump motors with faults in their rotors or capacitors
- e. Shaded-pole asynchronous motors

1.2 An RCD with a rated residual current not exceeding 30mA must be used with this product.



If you are not sure of the compatibility of your pool pump with this device, please contact your supplier or manufacturer before proceeding with installation.

TECHNICAL DATA

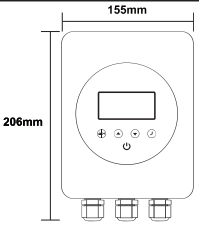
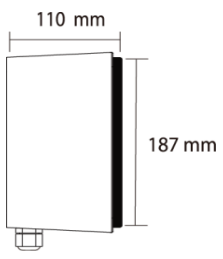
Model	INVPLUS1100	INVPLUS2200	Dimensions
Input Power	1 phase AC	1 phase AC	
Input Voltage	220~240V	220~240V	
Input Frequency	50Hz	50Hz	
Output Power	Max 1.1kW	Max 2.2kW	
Output Voltage	1ph, 0~240V	1ph, 0~240V	
Pump type	Single phase	Single phase	
Max. current	Max 6A	Max 12A	
Speed Range	1200~2900 rpm	1200~2900 rpm	
Cooling	Ventilation	Ventilation	
Net Dimension	187*110*155mm	187*110*155mm	
Gross/Net Weight	3.0/2.7Kg	3.0/2.7Kg	
IP Rating	55	54	

BEFORE INSTALLATION

Make sure the place you choose for installation meets the following conditions:

- Ambient temperature from -10~40°C
- 45 to 90 percent relative humidity, non-condensing
- Less than 1000m above sea level
- Keep out of direct sunlight
- Good ventilation

For optimum ventilation, please make sure it is installed with a minimum clearance surrounding it as shown in Fig.2

Blocked ventilation or an enclosed space with limited air flow may cause overheating or potential operational failure of the inverter.

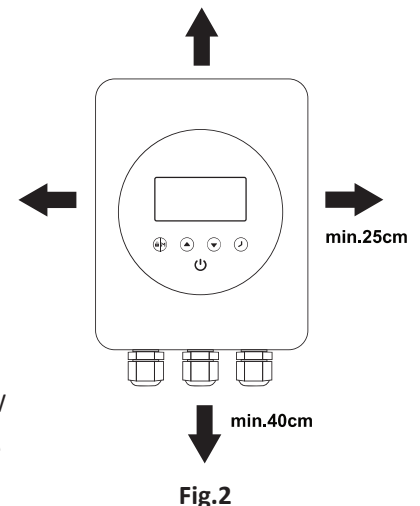

Upon receipt of this device, check for damage to the packaging or product. DO NOT PROCEED with installation if any damage is found; contact your supplier. Do not use extension leads with the device. This can pose a danger particularly in the vicinity of a swimming pool.

CONNECTING TO POOL PUMP

Please follow these steps and the wiring diagram for the correct connection. The warranty may be compromised if the device is not installed in accordance with instructions described in this manual.

Only ONE pump can be connected to the inverter. Please do not connect any other appliance to the output.

Mark the hole locations on the wall with the template provided, drill and insert the expansion plugs supplied, fit the screws and hang the device on the screws.

4.1 Turn off all electrical supply to the pool pump, unplug the pool pump it from the main switch or at the chlorinator which provides electrical power to the pump.

4.2 Plug the pool pump into the device's "Power socket" see Fig.3 below (PUMP CONNECTION ONLY).

4.3 Plug the device into the main switch/chlorinator/timer connection where the pump was originally plugged into.

4.4 Switch power back on.

4.5 Ensure chlorinator/timer is active which will put power the controller

4.6 Now the device is ready to operate and will illuminate

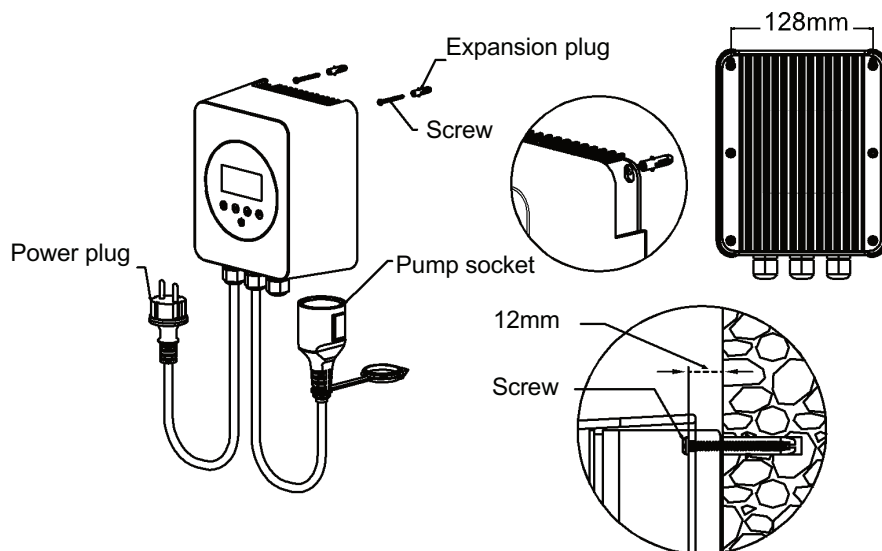
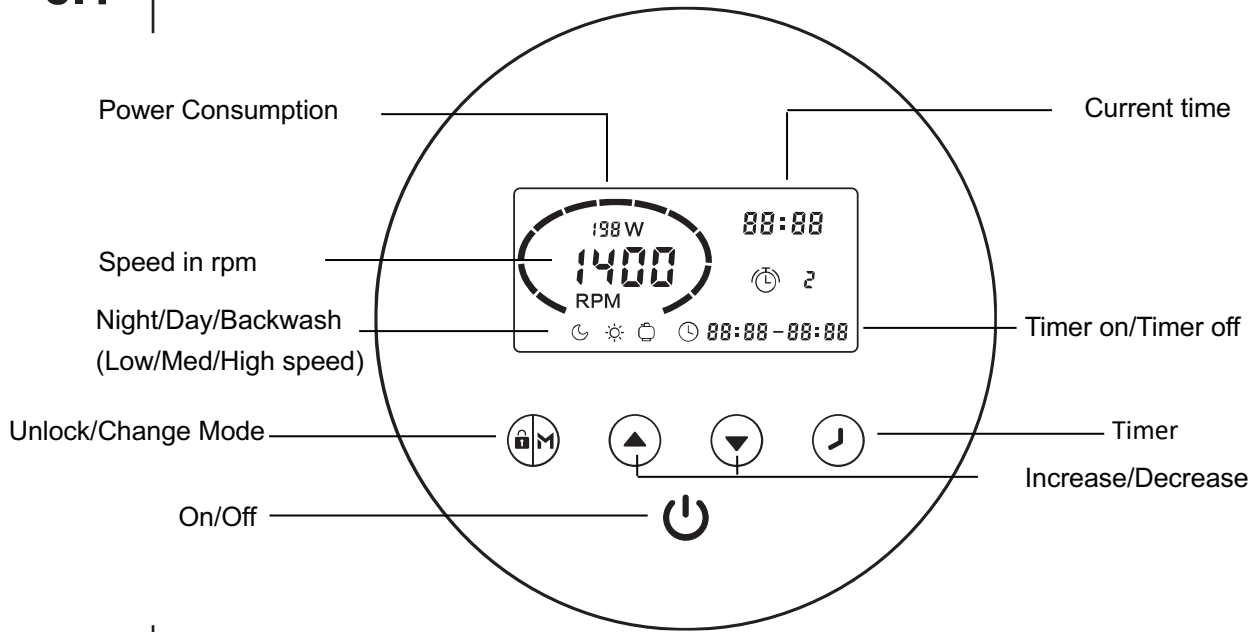

Fig. 3

Above figure is for reference only, plug & socket may vary for different countries/regions.

SETTINGS & OPERATION

5.1 CONTROL PANEL



5.2 MODE SELECTION

The variable speed controller has 3 modes (speed ranges). You can either run your pump at a constant speed choosing from “M” or set up to 4 timers for daily operation, each with an individual speed.

Mode	Speed range	Default speed
Night (Low)	1200~1650 rpm	1400 rpm
Day (Medium)	1700~2400 rpm	2000 rpm
Backwash (High)	2450~2900 rpm	2900 rpm

- ① When plugged in, lights up, hold for 3 seconds to unlock the screen. Press to start.
- ② Upon starting, pump will run at maximum speed of 2900 rpm for one-minute self-priming. (This can be increased to 10 minutes – see Parameter settings Section 5.5)
- ③ After self priming press to choose a running speed, use or arrows to adjust by 50rpm increments to a specific running speed

Once the pump has finished priming, the inverter will automatically switch the pump to the pre-set speed, indicates the pump is running and showing current rpm and power consumption.

5.3 | TIMER SETTING

Note: If the unit is not operating and the ⌚ symbol is flashing this means that it is waiting for the next on timer to start.

To run the pump at a different times or speeds to take advantage of lower electricity tariffs during the night or for higher speed cleaner operation, you can set up to 4 timers.

Step1: Press ⌚ to enter timer setting. (⌚ 0) means its selected the current time settings for the controller

Step2: Use ▲ or ▼ to set current time. Pressing ⌚ moves between the starting and ending time, and the speed. Increase or decrease the numbers using ▲▼.

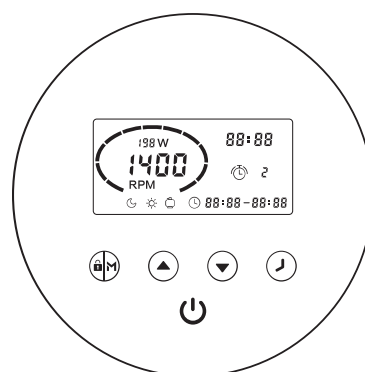

Step3: Repeat the above steps to set the other 3 timers.

Step4: Hold ⌚ for 3 seconds or wait 10 seconds to save settings automatically.

A flashing ⌚ **88:88 - 88:88** indicates the device is waiting for start time.

Step5: press ⌚ to check all 4 timers to ensure there are no invalid setting.

* Any overlapping of timer periods will be considered as invalid and the device will only run based on the previous valid timer setting.

* During timer setting, if you want to abandon it, hold 🔒 for 3 seconds.

Note:

* If inactive for 1 minute, the screen will lock automatically.

Hold 🔒 for 3 seconds to unlock the device.

* The device has power-off memory, operation will resume upon power restoration.

* Under OFF mode, hold ▲⌚ for 3 seconds to retrieve factory setting.

5.4 | EXTERNAL CONTROL

External control can be enabled via the following contacts. However, even if it's working via an external controller, pressing  can stop the device. Please do not apply voltage to these inputs.

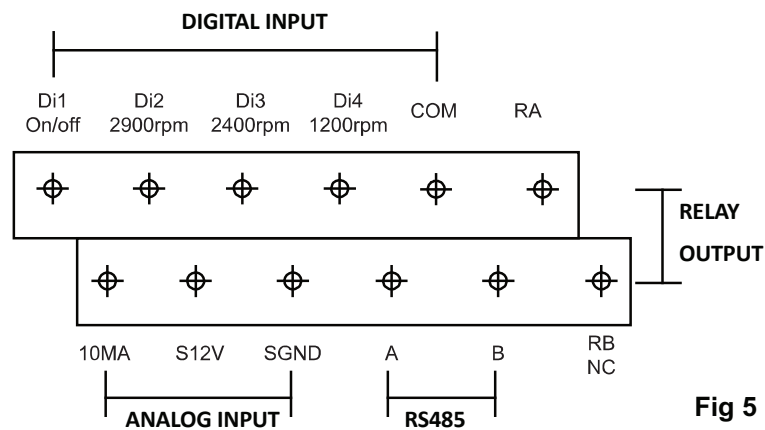

Fig 5

E.g.: To enable external speed control via digital input, connect one of the digits from Di2/3/4 to COM.



Do not touch the heat sink while the device is in operation or until at least 30 mins after it has been switched off. Keep it out of reach of children.



Because of high voltage conversion components contained in the device, do not try to disassemble or replace any components in case of malfunction or breakdown. Before serving on the unit, wait till the power light turned off or at least 3 minutes after power plug has been plugged off from input supply.

5.5 | EXTERNAL CONTROL

Under OFF mode, hold ▲▼ for 3 seconds to enter parameter settings.

Parameter	Description	Default setting	Setting range
1	Priming time	1 minutes	0~10min, by 1 minute increments
2	Minimum RPM	1200rpm	1200~2000rpm, by 100rpm increments
3	Di2	2900 rpm	1200~2900rpm, by 100rpm increments
4	Di3	2400 rpm	1200~2900rpm, by 100rpm increments
5	Di4	1200 rpm	1200~2900rpm, by 100rpm increments
6	Priming RPM	2900 rpm	1200~2900rpm, by 100rpm increments

PROTECTION & ERROR CODES

Item	Code	Description	Analysis
1	E001	Abnormal input voltage	Not faulty
2	E002	Output over current	Not faulty
3	E101	Heat sink over heat	Contact your supplier
4	E102	Heat sink sensor error	Contact your supplier
5	E103	Master driver board error	Contact your supplier
6	E201	Circuit board error	Contact your supplier
7	E202	Master board EEPROM reading failure	Contact your supplier
8	E203	RTC time reading error	Contact your supplier
9	E204	Keyboard EEPROM reading failure	Contact your supplier
10	E205	Communication error	Contact your supplier
11	AL01	Auto speed reduction against high temperature	Contact your supplier

Note:

1. AL01 is not an error indication: when it appears the inverter will automatically switch to a lower speed to self protect against high internal temperature. When the temperature drops back to normal operating range (65°C) the inverter will resume at the preset speed. If this happens often please check correct ventilation requirements and move out of direct sunlight.
2. If code E002/E101/E103 occurs, and the cause for the code appearing is cleared. I.e E101 heat sink is within normal operating range again the device will resume working automatically, however when it appears a fourth time, the device will stop working and display the code continuously, to resume operation, disconnect power to the device by unplugging and power restart again.

If code continues to be displayed please contact the Madimack support line on 1300 899 737 or email support@madimack.com.au

COMMISSIONING AND CHECKS

EMinimum water turn over

Please note that the minimum flow rate should be set to achieve the required turn over rate. Please contact your pool specialist for further information or contact Madimack Support.

Minimum flow rate chlorinator/other devices

Please ensure the minimum flow rate is set for any devices on the pool system. This includes the chlorinator / sanitizing cell. As a guide the cell must be completely covered in water at the lowest speed. If it is not achieved please increase the flow rate.

EXCLUSIONS

Under no circumstances should the manufacturer be held liable for any consequences resulting from inappropriate, incorrect installation, or mismatching of the product to pool pumps that are not compatible.

The manufacturer reserves the right to change the specification of the product, its performance or the contents of the User Guide without notice in case of technical upgrade. Madimack are not responsible for the failure of any pump connected to the device. The variable speed controller should not be installed in exposed locations or corrosive environments.

WARRANTY

The Madimack variable speed pump controller is warranted for manufacturing defect for up to 12 months after the purchase date with a valid invoice. Madimack does not cover damages resulting for any misuse, incorrect installation and does not cover other systems attached to or from the device.

RECYCLING

When disposing the product, please hand it over to a designated collection point for the recycling of waste electrical and electronic equipment. The separate collection and recycling of waste equipment at the time of disposal will help ensure that it is recycled in a manner that protects human health and the environment. Contact your local authority for information on where you can drop off your unit for recycling.